



QUICK START GUIDE

Take a look below at these simple steps to get started and make the most of the benefits of this device.

SMARTPHONE INSTRUCTIONS

STEP 1

Ensure the vehicle is on and running.
Wait for the camera to say 'BlackVue for your safe drive'.

Download your applicable app by scanning in the QR code above, or search 'BlackVue' in your App Store.

Open the BlackVue app.



IOS APP



ANDROID APP



APP STORE

STEP 2

Do not sign up for a BlackVue Account, instead use **Click 'Continue as Guest'**.

Click the option **'Connect to Wi-Fi camera'**.

You'll then see a page that says **'Connect your phone to the camera'** temporarily swipe away the BlackVue App and open your **Phone Settings**.

STEP 3

In your **Phone Settings**, open Wi-Fi, and connect to **"Blackvue_750GPRO-XXXXXX"**.

If your dash camera does not appear on the automatic search, be sure to check if your cameras WiFi is on:

Look for a white light as pictured above.
If OFF, press the Wi-Fi connect button on the right hand side of the camera.

The **Password to connect is 'blackvue'**. Once connected you may go back and open the BlackVue App.

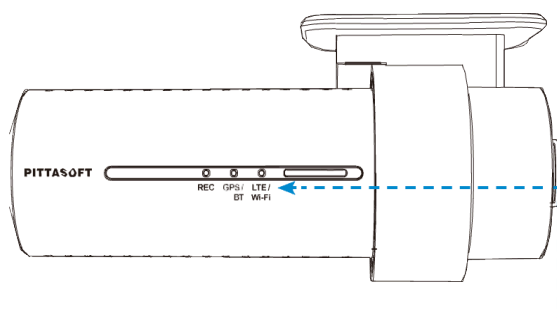

STEP 4

You can now press **'Continue'** and review your videos.

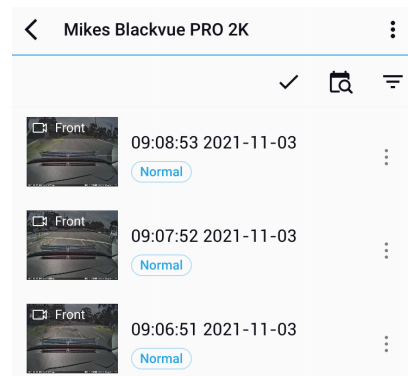

Please refer to your User Manual for more in depth information.

FOR FURTHER SUPPORT CALL 1800 818 288

CONGRATULATIONS

BlackVue Dash Camera



Congratulations on the purchase of your new BlackVue Dash Camera, Australia's leading dash camera. This document is designed to help you set up and use this device with ease. Keep this in the car or a safe spot, for easy reference if required.

Take a quick look over the diagrams below to get a better understanding of managing video files from the Dash Camera.

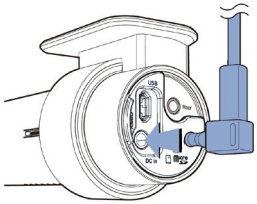

Please ensure your dash camera is plugged in to be operational.
FOR SUPPORT CALL (08) 6267 5167 (AWST)

HOW TO REMOVE THE SD CARD:

- First, unplug the power cord to turn off the dashcam. (SEE DIAGRAM A)
- Then open the cover of the microSD card slot. (SEE DIAGRAM B)
- To remove the microSD card: gently press on the card to release the lock, then carefully pull the card out. (SEE DIAGRAM C)
- To insert the microSD card, gently push the card into the slot until it locks into place and close the cover.

DIAGRAM A

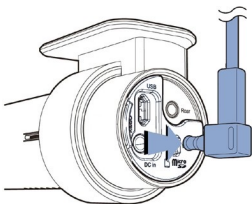

Remove Power Cable

DIAGRAM B

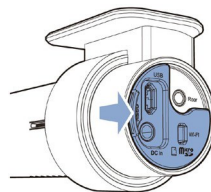

Open Side Cover

DIAGRAM C

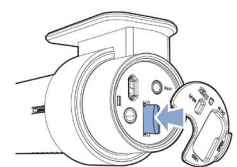

Remove Memory Card

PLAYING AND MANAGING VIDEO FILES USING YOUR COMPUTER:

- Insert the card into the microSD card reader located in your glove box and connect it to a computer.
- Download the optional BlackVue Viewer from www.blackvue.com > Support > Downloads and install it on your computer.

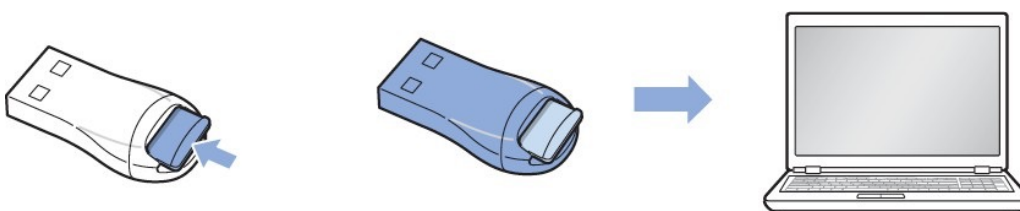



QUICK START GUIDE

For connecting a BlackVue Dash Camera via the BlackVue App via smartphone.

SMARTPHONE INSTRUCTIONS

STEP 1

Ensure the vehicle is on and running. Wait for the camera to say 'BlackVue for your safe drive'.

Download your applicable app by scanning in the QR code below, or search 'BlackVue' in your App Store. Open the BlackVue App.



IOS APP



ANDROID APP

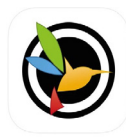

APP STORE

STEP 2

You'll first need to create an Account. Once created, click 'Camera' located at the bottom. Next, click the blue '+ Camera'.

You'll be prompted to select 'Seamless Pairing model' - click 'next'.

The app will now automatically search for your dash camera, once found click the name **Blackvue_750GPRO-XXXXXX**

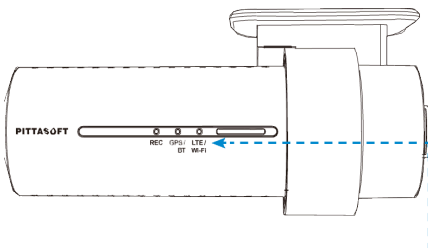

STEP 3

If your dash camera does not appear on the automatic search, be sure to check if your cameras WiFi is on: Look for a white light as pictured above.

If OFF, press the Wifi connect button on the right hand side of the camera.

STEP 4

Your app will now ask you to wave along the left hand side of the camera, to confirm you are connecting to the correct camera (so no one else can try to also connect to your camera).

If you've done this correctly you'll hear the camera beep.

STEP 5

Your camera is now successfully paired. You'll now be asked to connect your camera to the Cloud - this step is optional.

For now, click 'Later'.

STEP 6

If Prompted to 'accept, allow or join' be sure to accept these or you may not be able to review or save recorded footage.

Once Joined, click 'Playback'.

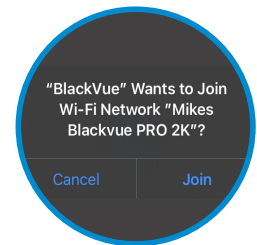

STEP 7

Now that you are connected, click on your dash cameras name to view a list of videos it has been recording. You can replay any of these videos to view a copy.

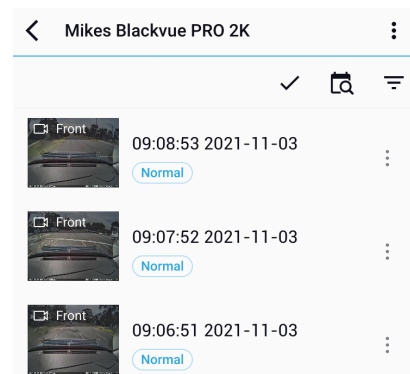

STEP 8

If you find a video of interest and you need to save a copy to your smartphone for sharing, click the download button located in the top right hand corner whilst watching a video. Once saved it will appear in the "Downloaded Videos" section.



Please refer to your User Manual for more in depth information.

FOR FURTHER SUPPORT CALL (08) 6267 5167 (AWST)